





SAP: AE KPL VKT 100 161S DINÖSE GASF

Commande de freinage diamètre carré 100, 161S avec anneau DIN

Code article	Type	PTAC en kg	Charge à la rotule en kg	Cote B \square mm	Bielle réglable	Combinable au frein de roue AL-KO	Accrochage monté				
299 416	161S	950–1 600	100	100	oui	1637 / 2051	Anneau DIN	17	–	40	20
242 958	161S	950–1 600	100	100	oui	2361	Anneau DIN	17	–	40	20

Procès-verbal d'essai ECE n°

Commande de freinage : 361-0047-97



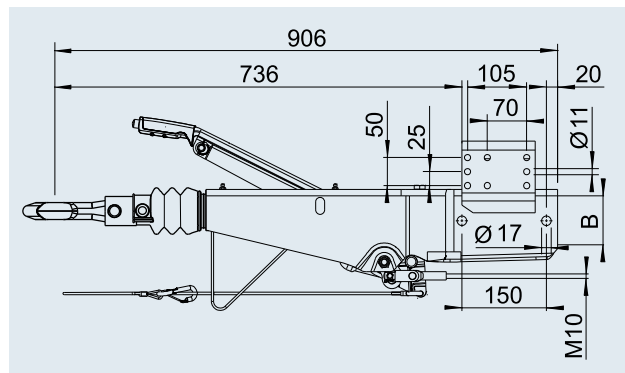

Homologation ECE n°

Timon : E1 55R-01 0267



SAP: AE KPL VKT 100 251S AK270 GASF

Commande de freinage diamètre carré 100, 251S avec AK270 et Soft-Dock

Code article	Type	PTAC en kg	Charge à la rotule en kg	Cote B \square mm	Bielle réglable	Combinable au frein de roue AL-KO	Accrochage monté				
1 253 078	251S	1 500–2 600	100	100	oui	1637 / 2051	AK 270	14	–	10	20
1 731 207	251S	1 500–2 600	100	100	oui	2361	AK 270	14	–	10	20

Procès-verbal d'essai ECE n°

Commande de freinage : 361-0044-97



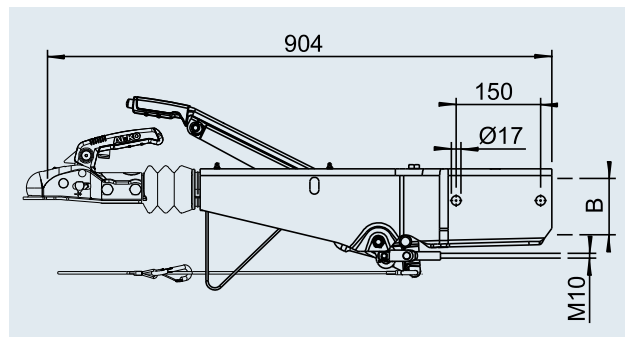

Homologation ECE n°

Timon : E1 55R-01 0268



SAP: STUETZRADHALTER GESCHW

Support de roue jockey 800 kg

Code article				
1 654 234	7,3	–	–	2

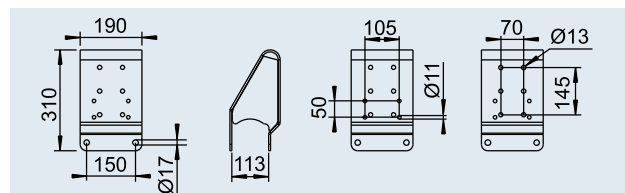





COMMANDES DE FREINAGE POUR TIMON CARRÉS

1 500 à 2 600 kg

SAP: AE KPL VKT 100 251S AK270 GASF

Commande de freinage diamètre carré 251S avec AK 270 et Soft-Dock

Code article	Type	PTAC en kg	Charge à la rotule en kg	Cote B \square mm	Bielle réglable	Combinable au frein de roue AL-KO	Accrochage monté				
1 251 908	251S	1 500–2 600	100	100	oui	1637 / 2051	AK 270	20	–	25	2
1 251 909	251S	1 500–2 600	100	100	oui	2361	AK 270	20	–	25	20

Procès-verbal d'essai ECE n°

Commande de freinage : 361-0044-97



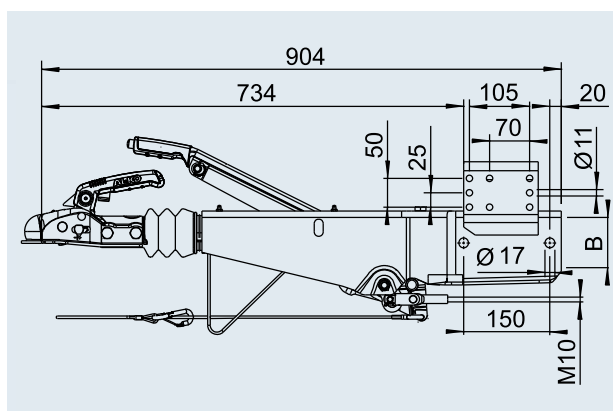

Homologation ECE n°

Timon : E1 55R-01 0268



SAP: AE KPL VKT 100 251S DINÖSE GASF

Commande de freinage diamètre carré 251S avec anneau DIN

Code article	Type	PTAC en kg	Charge à la rotule en kg	Cote B \square mm	Bielle réglable	Combinable au frein de roue AL-KO	Accrochage monté				
240 010	251S	1 500–2 600	100	100	oui	1637 / 2051	Anneau DIN	21	–	25	20
242 960	251S	1 500–2 600	100	100	oui	2361	Anneau DIN	21	–	25	20

Procès-verbal d'essai ECE n°

Commande de freinage : 361-0044-97

Homologation ECE n°

Timon : E1 55R-01 0268

