





OVERRUN DEVICE V CAST-IRON

with lowering handbrake lever; 1,600 to 3,500 kg

SAP: AE KPL V PROFI3000 AK301 ASB-HB G

Overrun device Profi V with AK 301

Part no.	Type	Gross weight in kg	Nose load in kg	Version of drawbar installation	Change-over relay lever?	Can be combined with AL-KO wheel brake	Hitch mounted				
1 224 654	AE 3000	1,600 – 3,000	150	top + bottom	No	3062 / 3081	AK 301	23	–	15	20
1 251 464	AE 3000	1,600 – 3,000	150	top + bottom	No	2361	AK 301	23	–	15	20
1 251 465	AE 3000	1,600 – 3,000	150	top + bottom	No	2051	AK 301	23	–	15	20

SCOPE OF DELIVERY

- I Overrun device (see illustration)
- I Plug holder (loose)
- I Instructions for use (loose)

ECE test report no.

Overrun device: 361-016-12



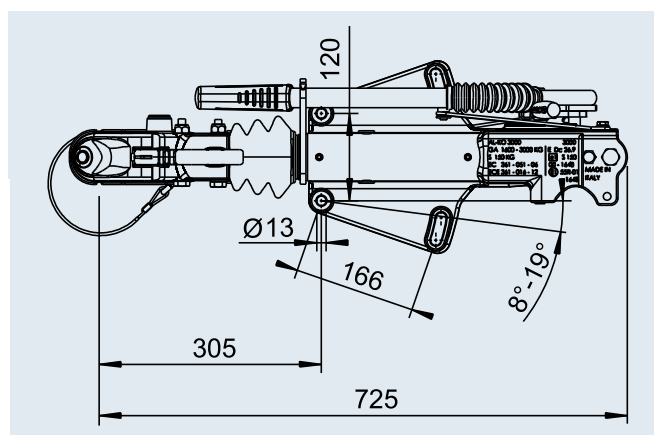

ECE type approval no.

Drawbar installation: E1 55R-01 1648



SAP: AE KPL V PROFI3500 AK351 ASB-HB

Overrun device Profi V with AK 351

Part no.	Type	Gross weight in kg	Nose load in kg	Version of drawbar installation	Change-over relay lever?	Can be combined with AL-KO wheel brake	Hitch mounted				
1 224 995	AE 3500	2,000 – 3,500	150	top + bottom	No	2361	AK 351	29	–	15	20
1 224 996	AE 3500	2,000 – 3,500	150	top + bottom	No	3062 / 3081	AK 351	29	–	15	20

SCOPE OF DELIVERY

- I Overrun device (see illustration)
- I Plug holder (loose)
- I Instructions for use (loose)

ECE test report no.

Overrun device: 361-016-12

ECE type approval no.

Drawbar installation: E1 55R-01 1649

