





# FRENO A REPULSIONE QUADRO

senza timone 2.500 - 3.500 kg

**SAP:** AE KPL VKT 120 2,8VB AK351 FEDS

**AE VKT 2,8 VB con giunto a sfera AK 351**

Cod. art.	Tipo	Portata complessiva in kg	Carico d'appoggio in kg	Misura $\square$ B	Leva di rinvio reversibile?	Combinabile con freno ruota AL-KO	Gancio montato				
1 251 945	2,8VB1/-C	2.500 - 3.500	150	120	no	1637/2051	AK 351	26	-	10	20
<b>1 251 578</b>	2,8VB1/-C	2.500 - 3.500	150	120	no	2361	AK 351	26	-	10	2
1 251 895	2,8VB1/-C	2.500 - 3.500	150	120	no	3062/3081	AK 351	26	-	10	20

**N. verbale di approvazione ECE**

Freno a repulsione: 361-0045-97



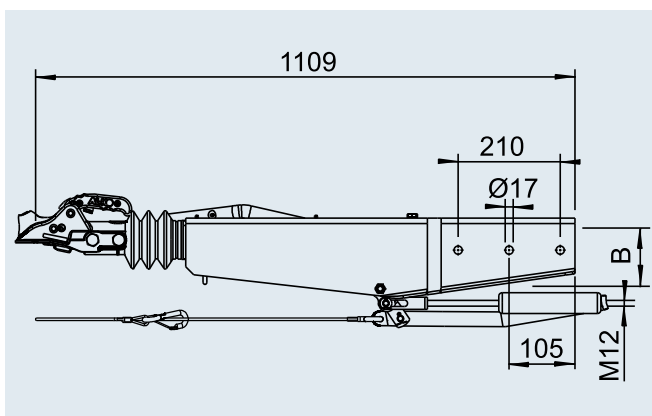

**N. approvazione ECE**

Carcassa repulsore: E1 55R-01 0378



**SAP:** AE KPL VKT 120 2,8VB AK351 FEDS

**Portaruotino d'appoggio 800 kg**

Cod. art.				
<b>1 654 240</b>	6,3	-	-	2

