





FRENO A REPULSIONE V

1.550 - 3.000 kg



SAP: AE KPL V ST UN 251G AK301 GASF

AE V 251G acciaio con PROFI V AK 301

Cod. art.	Tipo	Portata complessiva in kg	Carico d'appoggio in kg	Attacco carcassa repulsore	Leva di rinvio reversibile?	Combinabile con freno ruota AL-KO	Gancio montato		  		
1 251 288	251G acciaio	1.550 - 3.000	120	sotto	no	1637/2051	AK 301	17	-	40	20

N. verbale di approvazione ECE

Freno a repulsione: 361-0043-97



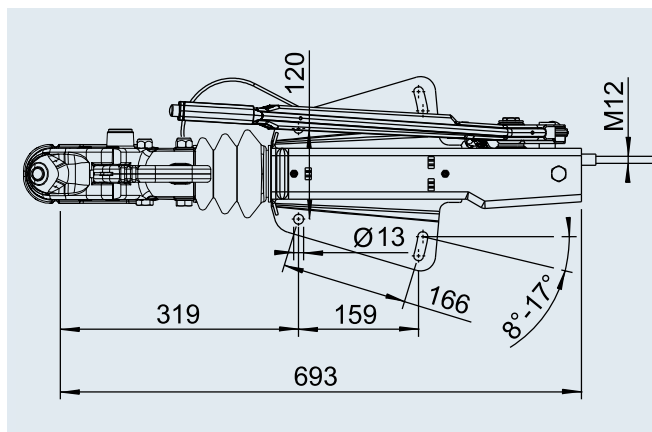

N. approvazione ECE

Carcassa repulsore: E1 55R-01 0466



SAP: AE KPL V ST OB 251G DINÖSE GASF

AE V 251G acciaio con golfare DIN

Cod. art.	Tipo	Portata complessiva in kg	Carico d'appoggio in kg	Attacco carcassa repulsore	Leva di rinvio reversibile?	Combinabile con freno ruota AL-KO	Gancio montato		  		
249 250	251G acciaio	1.550 - 3.000	120	sopra	no	1637/2051	golfare DIN	18	-	40	20

N. verbale di approvazione ECE

Freno a repulsione: 361-0043-97

N. approvazione ECE

Carcassa repulsore: E1 55R-01 0466

