





FRENO A REPULSIONE V ACCIAIO

con leva del freno a mano con molla; 950 - 2.700 kg

SAP: AE KPL V OB 161S AK161 FEDS

Freno a repulsione V 161S con AK 161

Cod. art.	Tipo	Portata complessiva in kg	Carico d'appoggio in kg	Montaggio carcassa repulsore	Leva di rinvio reversibile?	Combinabile con freno ruota AL-KO	Gancio montato				
1 253 077	161 S	950–1.600	100	in alto	no	1637/2051	AK 161	17	–	15	20

FORNITURA

- I Freno a repulsione (v. fig.)
- I Portapresa (sciolto)
- I Istruzioni per l'uso (sciolto)

N. verbale di approvazione ECE

Freno a repulsione: 361-0047-97



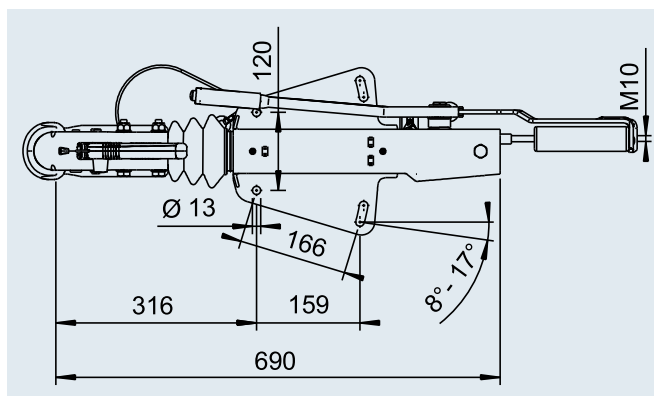

N. approvazione ECE

Carcassa repulsore: E1 55R-01 0229



SAP: AE KPL V OB 251S AK270 FEDS

Freno a repulsione V 251S con AK 270

Cod. art.	Tipo	Portata complessiva in kg	Carico d'appoggio in kg	Montaggio carcassa repulsore	Leva di rinvio reversibile?	Combinabile con freno ruota AL-KO	Gancio montato				
1 253 084	251 S	1.500–2.700	120	in alto	no	1637/2051	AK 270	19	–	15	20

FORNITURA

- I Freno a repulsione (v. fig.)
- I Portapresa (sciolto)
- I Istruzioni per l'uso (sciolto)

N. verbale di approvazione ECE

Freno a repulsione: 361-0044-97

N. approvazione ECE

Carcassa repulsore: E1 55R-01 0227

