





ENGANCHE DE INERCIA CUADRADO

sin lanza 2.500 hasta 3.500 kg

SAP: AE KPL VKT 120 2,8VB AK351 FEDS

AE VKT 2,8 VB con cabezal AK 351

N.º de ref.	Tipo	Peso total en kg	Carga en bola en kg	Cota \square B	Palanca de inversión universal	Combinable con freno de rueda AL-KO	Enganche montado				
1 251 945	2,8VB1/-C	2.500 - 3.500	150	120	no	1637 / 2051	AK 351	26	-	10	20
1 251 578	2,8VB1/-C	2.500 - 3.500	150	120	no	2361	AK 351	26	-	10	2
1 251 895	2,8VB1/-C	2.500 - 3.500	150	120	no	3062 / 3081	AK 351	26	-	10	20

N.º de homologación ECE

Enganche de inercia: 361-0045-97



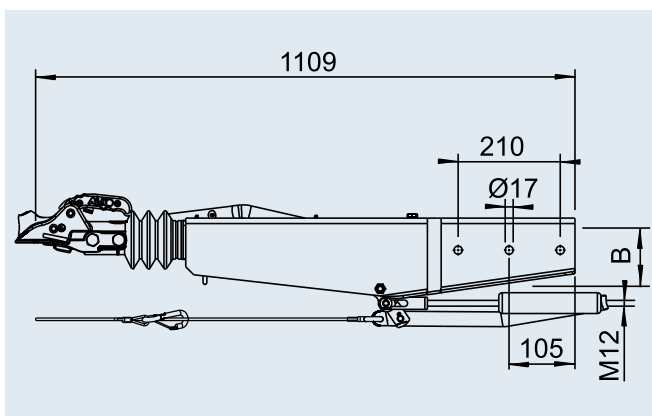

N.º de homologación de modelo ECE

Instalación de lanza de remolque: E1 55R-01 0378



SAP: AE KPL VKT 120 2,8VB AK351 FEDS

Soporte rueda jockey 800 kg

N.º de ref.				
1 654 240	6,3	-	-	2

