





# COMMANDES DE FREINAGE POUR TIMONS CARRÉS

## 2 500 à 3 500 kg

**SAP:** AE KPL VKT 120 2,8VB AK351 FEDS

**Commande de freinage diamètre carré 2,8 VB avec AK 351**

Code article	Type	PTAC en kg	Charge à la rotule en kg	Cote <input checked="" type="checkbox"/> B	Bielle réglable	Combinable au frein de roue AL-KO	Accrochage monté				
1 251 945	2,8VB1/-C	2 500 - 3 500	150	120	non	1637 / 2051	AK 351	26	-	10	20
1 251 578	2,8VB1/-C	2 500 - 3 500	150	120	non	2361	AK 351	26	-	10	2
1 251 895	2,8VB1/-C	2 500 - 3 500	150	120	non	3062 / 3081	AK 351	26	-	10	20

**Procès-verbal d'essai ECE n°**

Commande de freinage : 361-0045-97



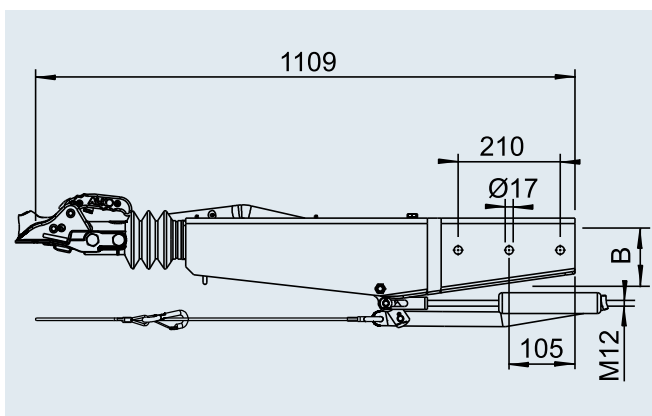

**Homologation ECE n°**

Timon : E1 55R-01 0378



**SAP:** AE KPL VKT 120 2,8VB AK351 FEDS

**Support de roue jockey 800 kg**

Code article				
1 654 240	6,3	-	-	2

