





COMMANDES DE FREINAGE AVEC SEMELLE EN V

950 à 1 600 kg



SAP: AE KPL V UN 161S AK161 GASF

Commande V 161S avec AK 161 et Soft-Dock

Code article	Type	PTAC en kg	Charge à la rotule en kg	Version commande de freinage	Bielle réglable	Combinable au frein de roue AL-KO	Accrochage monté				
1 251 914	161 S	950–1 600	100	bas	non	1637 / 2051	AK 161	12	–	20	2
1 251 915	161 S	950–1 600	100	bas	non	2361	AK 161	12	–	20	2

Procès-verbal d'essai ECE n°

Commande de freinage : 361-0047-97



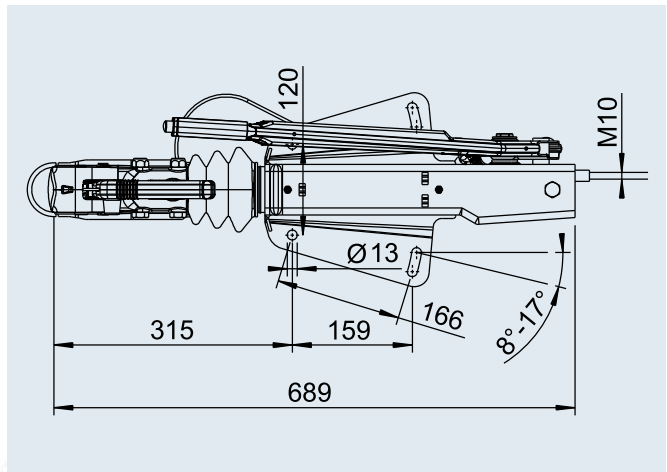

Homologation ECE n°

Timon : E1 55R-01 0229



SAP: AE KPL V OB 161S DINÖSE GASF

Commande V 161S avec anneau DIN

Code article	Type	PTAC en kg	Charge à la rotule en kg	Version commande de freinage	Bielle réglable	Combinable au frein de roue AL-KO	Accrochage monté				
299 319	161 S	950–1 600	100	haut	non	1637 / 2051	Anneau DIN	14	–	40	2
242 935	161 S	950–1 600	100	haut	non	2361	Anneau DIN	14	–	40	2

Procès-verbal d'essai ECE n°

Commande de freinage : 361-0047-97

Homologation ECE n°

Timon : E1 55R-01 0229

