





# AUFLAUFEINRICHTUNG V

950 bis 1.600 kg



**SAP:** AE KPL V UN 161S AK161 GASF

**AE V 161S mit AK 161 und Soft-Dock**

Bestell-Nr.	Typ	Gesamtgewicht in kg	Stützlast in kg	Ausführung Zugeinrichtung	Umlenkhebel umsteckbar?	Kombinierbar mit AL-KO Radbremse	Kupplung montiert				
1 251 914	161 S	950–1.600	100	unten	nein	1637 / 2051	AK 161	12	–	20	2
1 251 915	161 S	950–1.600	100	unten	nein	2361	AK 161	12	–	20	2

**ECE-Prüfprotokoll-Nr.**

Auflaufeinrichtung: 361-0047-97



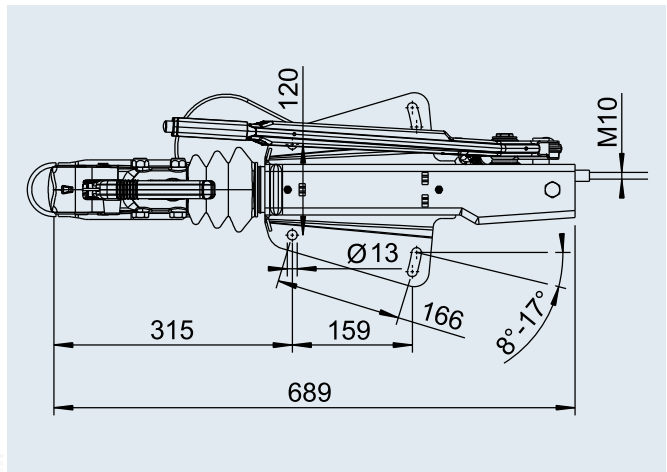

**ECE-Typgenehmigungs-Nr.**

Zugeinrichtung: E1 55R-01 0229



**SAP:** AE KPL V OB 161S DINÖSE GASF

**AE V 161S mit DIN-Öse**

Bestell-Nr.	Typ	Gesamtgewicht in kg	Stützlast in kg	Ausführung Zugeinrichtung	Umlenkhebel umsteckbar?	Kombinierbar mit AL-KO Radbremse	Kupplung montiert				
299 319	161 S	950–1.600	100	oben	nein	1637 / 2051	DIN-Öse	14	–	40	2
242 935	161 S	950–1.600	100	oben	nein	2361	DIN-Öse	14	–	40	2

**ECE-Prüfprotokoll-Nr.**

Auflaufeinrichtung: 361-0047-97

**ECE-Typgenehmigungs-Nr.**

Zugeinrichtung: E1 55R-01 0229

