









**SAP: AE KPL VKT 100 161S DINÖSE GASF****AE VKT 161 S – VKT 100 con golfare DIN**

Cod. art.	Tipo	Portata complessiva in kg	Carico d'appoggio in kg	Misura B ∅ mm	Leva di rinvio reversibile?	Combinabile con freno ruota AL-KO	Gancio montato				
299 416	161S	950 – 1.600	100	100	sì	1637/2051	golfare DIN	17	–	40	20
242 958	161S	950 – 1.600	100	100	sì	2361	golfare DIN	17	–	40	20

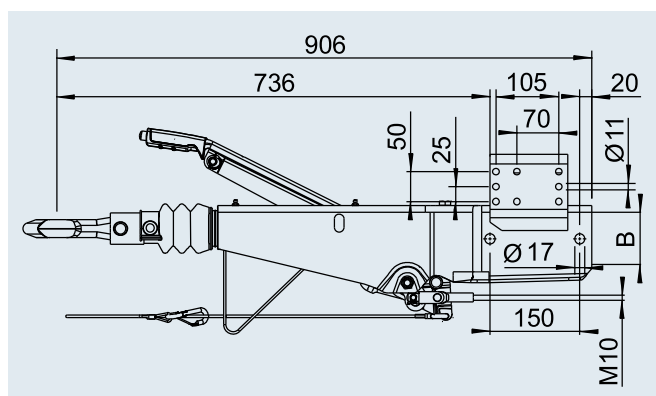
Freno a repulsione: 361-0047-97

Carcassa repulsore: E1 55R-01 0267





**SAP: AE KPL VKT 100 251S AK270 GASF****AE VKT 251S - VKT 100 con AK 270 e Soft-Dock**

Cod. art.	Tipo	Portata complessiva in kg	Carico d'appoggio in kg	Misura B ∅ mm	Leva di rinvio reversibile?	Combinabile con freno ruota AL-KO	Gancio montato				
1 253 078	251S	1.500 – 2.600	100	100	sì	1637/2051	AK 270	14	–	10	20
1 731 207	251S	1.500 – 2.600	100	100	sì	2361	AK 270	14	–	10	20

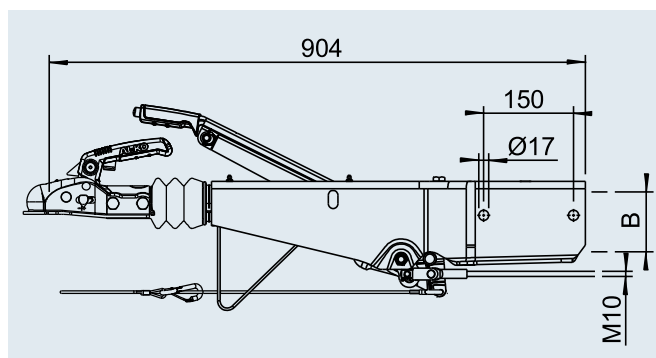
Freno a repulsione: 361-0044-97

Carcassa repulsore: E1 55R-01 0268

**SAP: STUETZRADHALTER GESCHW****Portaruotino d'appoggio 800 kg**

Cod. art.				
1 654 234	7,3	–	–	2

