





SAP: AE KPL VKT 60 90S/3 AK161 GASF

AE VKT 90S/3 con AK 161 con Soft-Dock

Cod. art.	Tipo	Portata complessiva in kg	Carico d'appoggio in kg	Misura B \varnothing mm	Leva di rinvio reversibile?	Combinabile con freno ruota AL-KO	Gancio montato				
1 251 902	90S/3	700 – 1.000	75	60	no	1637/2051	AK 161	11	-	50	2

N. verbale di approvazione ECE

Freno a repulsione: 361-033-92



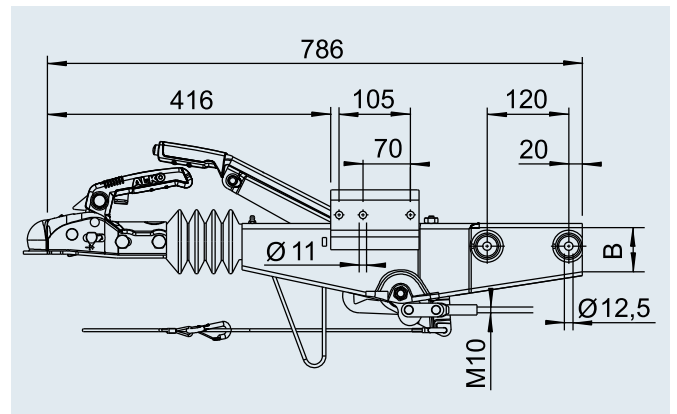

N. approvazione ECE

Carcassa repulsore: E1 55R-01 0233



SAP: AE KPL VKT 70 90S/3 AK161 GASF

AE VKT 90S/3 con AK 161 con Soft-Dock

Cod. art.	Tipo	Portata complessiva in kg	Carico d'appoggio in kg	Misura B \varnothing mm	Leva di rinvio reversibile?	Combinabile con freno ruota AL-KO	Gancio montato				
1 251 903	90S/3	700 – 1.000	75	70	no	1637/2051	AK 161	11	-	50	2

N. verbale di approvazione ECE

Freno a repulsione: 361-033-92

N. approvazione ECE

Carcassa repulsore: E1 55R-01 0233

