





SAP: AE KPL VKT 60 90S/3 AK161 GASF

Commande de freinage diamètre carré 90S/3 avec AK 161 et Soft-Dock

Code article	Type	PTAC en kg	Charge à la rotule en kg	Cote B ∇ mm	Bielle réglable	Combinable au frein de roue AL-KO	Accrochage monté				
1 251 902	90S/3	700 – 1 000	75	60	non	1637 / 2051	AK 161	11	-	50	2

Procès-verbal d'essai ECE n°

Commande de freinage : 361-033-92



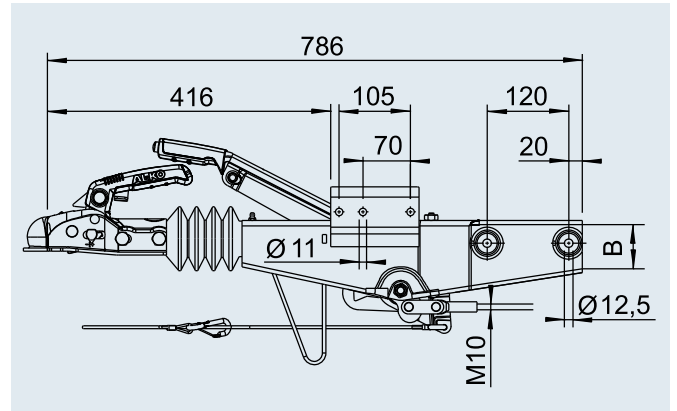

Homologation ECE n°

Timon : E1 55R-01 0233



SAP: AE KPL VKT 70 90S/3 AK161 GASF

Commande de freinage diamètre carré 90S/3 avec AK 161 et Soft-Dock

Code article	Type	PTAC en kg	Charge à la rotule en kg	Cote B ∇ mm	Bielle réglable	Combinable au frein de roue AL-KO	Accrochage monté				
1 251 903	90S/3	700 – 1 000	75	70	non	1637 / 2051	AK 161	11	-	50	2

Procès-verbal d'essai ECE n°

Commande de freinage : 361-033-92

Homologation ECE n°

Timon : E1 55R-01 0233

