





COMMANDES DE FREINAGE POUR TIMONS CARRÉS

450 à 1 000 kg

SAP: AE KPL VKT 60 60S/2 AK161 GASF

Commande de freinage diamètre carré 60S/2 avec AK 161 et Soft-Dock

Code article	Type	PTAC en kg	Charge à la rotule en kg	Cote B \square mm	Bielle réglable	Combinable au frein de roue AL-KO	Accrochage				
1 251 900	90S/3	450 – 750	75	60	non	1636G / 1637	AK 161	10	–	50	2

Procès-verbal d'essai ECE n°

Commande de freinage : 361-0126-97



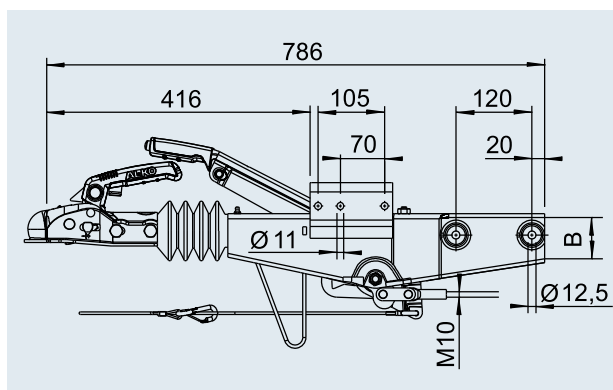

Homologation ECE n°

Timon : E1 55R-01 0234



SAP: AE KPL VKT 70 60S/2 AK161 GASF

Commande de freinage diamètre carré 60S/2 avec AK 161 et Soft-Dock

Code article	Type	PTAC en kg	Charge à la rotule en kg	Cote B \square mm	Bielle réglable	Combinable au frein de roue AL-KO	Accrochage				
1 251 901	60S/2	450 – 750	75	70	non	1636G / 1637	AK 161	11	–	50	20

Procès-verbal d'essai ECE n°

Commande de freinage : 361-0126-97

Homologation ECE n°

Timon : E1 55R-01 0234

