





# COMMANDES DE FREINAGE POUR TIMON CARRÉS

## 1 500 à 2 600 kg

**SAP:** AE KPL VKT 100 251S AK270 GASF

**Commande de freinage diamètre carré 251S avec AK 270 et Soft-Dock**

| Code article | Type | PTAC en kg    | Charge à la rotule en kg | Cote B $\varnothing$ mm | Bielle réglable | Combinable au frein de roue AL-KO | Accrochage monté |  |  |  |  |
|--------------|------|---------------|--------------------------|-------------------------|-----------------|-----------------------------------|------------------|---|---|---|---|
| 1 251 908    | 251S | 1 500 – 2 600 | 100                      | 100                     | oui             | 1637 / 2051                       | AK 270           | 20  | –   | 25  | 2   |
| 1 251 909    | 251S | 1 500 – 2 600 | 100                      | 100                     | oui             | 2361                              | AK 270           | 20  | –   | 25  | 20  |

**Procès-verbal d'essai ECE n°**

Commande de freinage : 361-0044-97



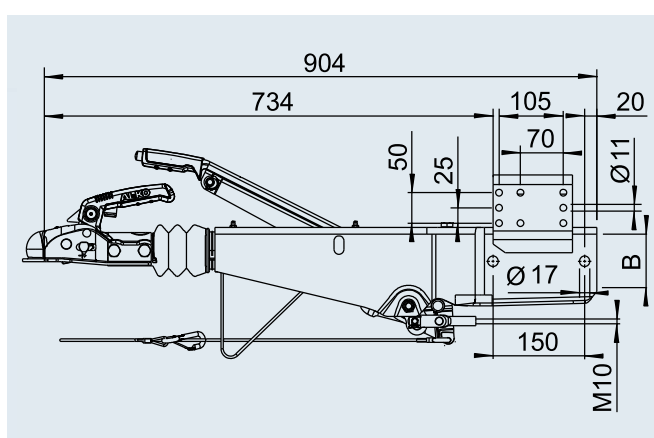

**Homologation ECE n°**

Timon : E1 55R-01 0268



**SAP:** AE KPL VKT 100 251S DINÖSE GASF

**Commande de freinage diamètre carré 251S avec anneau DIN**

| Code article | Type | PTAC en kg    | Charge à la rotule en kg | Cote B $\varnothing$ mm | Bielle réglable | Combinable au frein de roue AL-KO | Accrochage monté |  |  |  |  |
|--------------|------|---------------|--------------------------|-------------------------|-----------------|-----------------------------------|------------------|---|---|---|---|
| 240 010      | 251S | 1 500 – 2 600 | 100                      | 100                     | oui             | 1637 / 2051                       | Anneau DIN       | 21  | –   | 25  | 20  |
| 242 960      | 251S | 1 500 – 2 600 | 100                      | 100                     | oui             | 2361                              | Anneau DIN       | 21  | –   | 25  | 20  |

**Procès-verbal d'essai ECE n°**

Commande de freinage : 361-0044-97

**Homologation ECE n°**

Timon : E1 55R-01 0268

